

This product is protected by United States Federal and/or State Law, including Patent, Trademark and/or Copyright Laws.

WARNING! SHUT POWER OFF AT FUSE OR CIRCUIT BREAKER

The WC 600 AireControl System is equipped with a learning frequency function which has 32 code combinations to prevent potential interference from other remote units. The frequency on your Receiver and Transmitter units have been preset at the factory. We recommend setting up frequency while installing ceiling fan instead of using initial frequency set by factory. (Fig 1.) To avoid frequency interference from other surrounding fans Please use a small size tool to change the setting.

“D” and “O” DIP SWITCH (Fig. 1)

The “D”(DIMMER) selection is the light dimmable selection and is to be used with all bulbs except for CFL bulbs. The “O” (Dimmer OFF) selection is for the light to be turned ON and OFF only. It is to be used when using CFL bulbs as CFL bulbs are not dimmable.

Safety Precautions:

WARNING: Disconnect source of electrical power by removing the fuse or switching off circuit breakers.

- Do not use with solid state fans.
- Electrical wiring must meet all local and national electrical code requirements.
- Electrical source and fan must be 115/120 volts, 60 hz.
Maximum fan motor amps 1.5. Maximum light watts 190-incandescent only.

1. WALL TRANSMITTER INSTALLATION

WARNING! HOOK UP “IN SERIES” ONLY. DO NOT CONNECT NEUTRAL SUPPLY WIRE OF ELECTRIC CIRCUIT TO THE TRANSMITTER WALL SWITCH, DAMAGE TO THE TRANSMITTER WALL SWITCH AND POSSIBLE FIRE COULD OCCUR.

- Step 1.** Remove the existing wall plate and switch from the wall outlet box.
- Step 2.** Make the electrical connections as shown in Fig.2. If your outlet box has a ground wire (Green or Bare Copper) connect the Wall Transmitter’s ground wire to it. Otherwise connect the Wall Transmitter’s wire directly to one of the screws from the outlet box . Secure all wire connections with the plastic wire nuts provided.
- Step 3.** Carefully tuck the wire connections inside the outlet box. Use the screws provided to secure the wall transmitter and wall plate to the outlet box. (Fig. 3)
- Step 4.** Select desired frequency on the front of the transmitter.
- Step 5.** Return power to wall transmitter.

2. CREATING A UNIQUE FREQUENCY

- Step 1.** Within 60 seconds of turning the receivers AC power ON. Press the transmitter’s “Stop” button, or until the fans light blinks.
- Step 2.** Once the receiver has detected the frequency, the down light will blink twice. This will indicate that the receiver has learned the frequency that was previously selected on the transmitter.

Note: While creating a unique frequency and after the AC power is on, do not press any other button on the transmitter before pressing the “Stop” button doing so will cause the procedure to fail.

After completing the steps above, you should be able to operate the ceiling fan and light. If the fan is not responding to the transmitter, please turn the off power to the receiver and repeat Step 1 and 2.

3. OPERATING THE REMOTE CONTROL/WALL CONTROL

Restore power to ceiling fan and test the transmitter as below for proper operation:

- A.1. 2. 3. 4. 5 and 6 button
These six buttons are used to set the fan speed as follows:
1= minimum speed
2= low speed
3=medium low speed
4=medium speed
5=medium high speed
6= high speed

B.  Reverse button:
This button is used to change the direction of the rotation of the blades; forward for warm weather or reverse for the warm weather.

C.  button
This button turns the power off and on to fan.

D.  button
These buttons turn the light ON or OFF and dim by pressing and holding down the light button (If applicable with your fan) The following

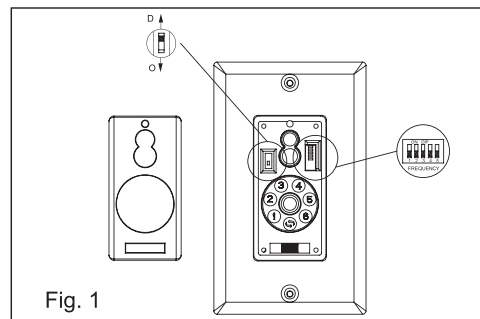

Fig. 1

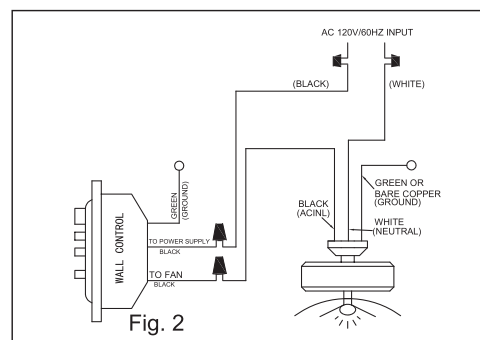

Fig. 2

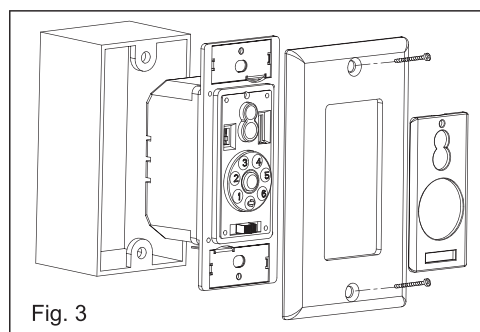





Fig. 3

instructions apply to ceiling fans that feature a DOWN light ( button) only or ceiling fans that feature an UP light ( button) and a DOWN light ( button) that are controlled independent of each other;

Press and release the button for desired light to turn the light ON or OFF. Press and hold the button to set the desired light brightness. The light will cycle between bright and dim settings as long as the button is pressed. The light key has an automatic auto-resume feature that allows the light to remain at the same brightness as the last time it was turned off.

NOTICE!

The wall control purchased is for use with DC motor ceiling fans only. DC ceiling fans cannot be installed with a solid state speed wall control or light dimmer. Doing so will permanently damage your fan's remote control receiving unit.

