

INSTALLATION INSTRUCTIONS

Item #N9633

READ AND SAVE THESE INSTRUCTIONS

PREPARING THE FIXTURE

1-Carefully unpack the new fixture and lay out all the parts on a clear area. Take care not to lose any parts necessary for installation.

Shut off the power at the fuse box or circuit breaker. If necessary, remove the old fixture, including the mounting hardware.

MOUNTING THE FIXTURE

2-(Fig.1)Pass the power cables through the appropriate hole in the support disk

3-(Fig.2)after passing the cables,screw the support disk to the ceiling box

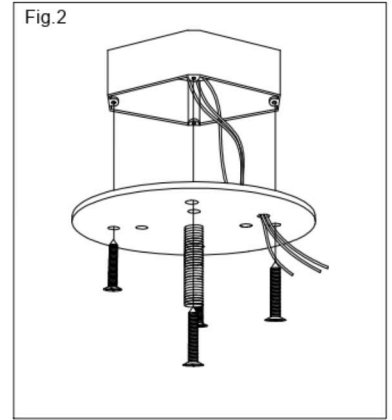
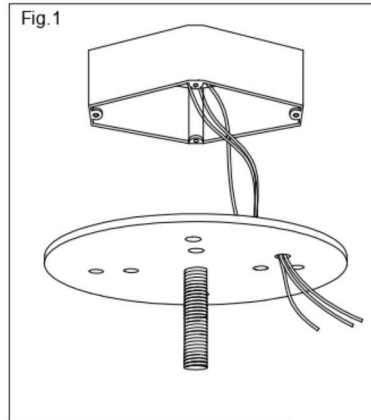

CONNECTING THE WIRES

4-(Fig.3) At this point, connect the electrical wires as shown in Fig. 3, making sure that all wire connectors are secured. If your outlet box has a ground wire (green or bare copper), connect the fixture's ground wire to it.

Otherwise, connect the fixture's ground wire directly to the mounting strap using the screw provided.

Tuck wire connectors neatly into outlet box.

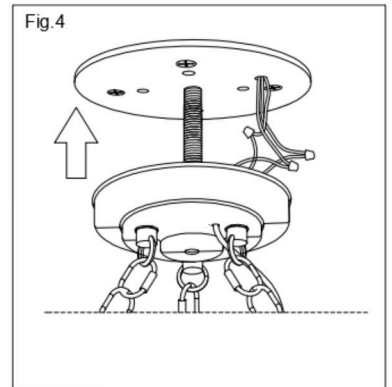
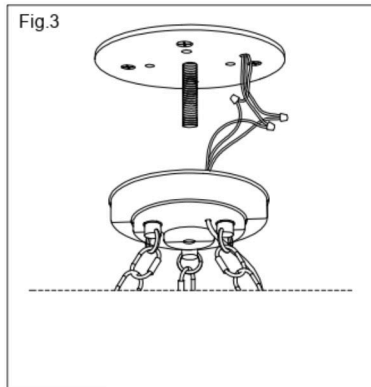

FINISHING THE INSTALLATION

5-(Fig.4) To mount the fixture to the ceiling, insert the all thread through the fixture. Use the decorative knob to tighten the fixture securely to the ceiling.

6-Install bulbs up to 60 watts each or LED equivalent (not included) in accordance with the fixture specification—DO NOT EXCEED THE MAXIMUM WATTAGE RATING! (NE PAS DEPASSER THE MAXIMAL NOMINAL PUISSANCE!).

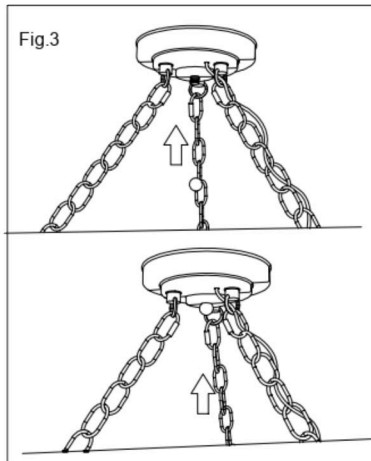

Your installation is now complete. Return power to the outlet box and test the fixture.

Note: Illustration on this manual is for installation purposes only. It may or may not be identical to the fixture purchased. Do not clean your light fixture or parts with water or cleanser.

