

INSTALLATION INSTRUCTIONS FOR N6893-898

READ AND SAVE THESE INSTRUCTIONS

WARNING! SHUT POWER OFF AT FUSE OR CIRCUIT BREAKER
AVERTISSEMENT! COUPER LE COURANT AU NIVEAU DES FUSIBLES OU DU DISJONCTEUR

ASSEMBLING THE FIXTURE (Fig.1) (Chandelier)

1. Shut off power at the fuse box or circuit breaker box. If necessary, remove existing fixture and its mounting hardware.
2. Carefully unpack your new fixture and lay out all the parts on a clean area. Take care not to lose any small parts necessary for installation. Check that all parts are included as shown in the illustration.
3. Install large rod (N) onto socket assembly (O) as shown in (Fig.1).
4. Install metal ring (M) to large rod (N), then thread small rod (L) onto all thread of metal ring (M), attach top ring (K) by threading onto rod (L) as shown in (Fig.1).
5. Attach fixture loop (J) by threading into all thread of top ring (K). Feed fixture wire and safety cable carefully through rod (N), metal ring (M), rod (L) and top ring (K) and fixture loop (J) as shown in (Fig.1).

HANGING THE FIXTURE (Fig.1)

6. Thread all thread (D) into ceiling loop (G) until snug.
7. Thread other end of all thread into crossbar (A) until snug. Note: The length of all thread into crossbar may be adjusted if necessary.
8. Use lock washer and hex nut (C) to secure all thread (D) into crossbar (A).
9. Take crossbar assembly and mount to outlet box (Not included) with mounting screws (B) (Size: #8-32N*L1"). The side of crossbar marked with "GND" must face out.
10. Determine desired hanging height and use a pair of proper chain pliers to remove and discard excess chain (I).
11. Open one end of quick link (H) and attach to fixture loop (J) and close quick link (H). Slip lock collar (F) and canopy (E) over chain (I) and allow them to rest on fixture body. Open other end of quick link (H) and attach to ceiling loop (G) and close quick link (H).
12. Carefully lace fixture's wires through chain, loop and all thread assembly.

CONNECTING THE WIRES (Fig.2)

13. Connect the electrical wires as shown in Fig.2, making sure that all wire connectors are secured. If your outlet has a ground wire (green or bare copper), connect fixture's ground wire to it. Otherwise, connect fixture's ground wire directly to crossbar (A) using green screw provided.
14. Tuck wire connections neatly into outlet box.
15. Raise canopy (E) onto ceiling loop (G) and secure with lock collar (F). (Fig. 1)

Fig.1

Set# A-012

-Crossbar

-Green Screw

-Mounting Screw *2

Chain# HCH2072-898

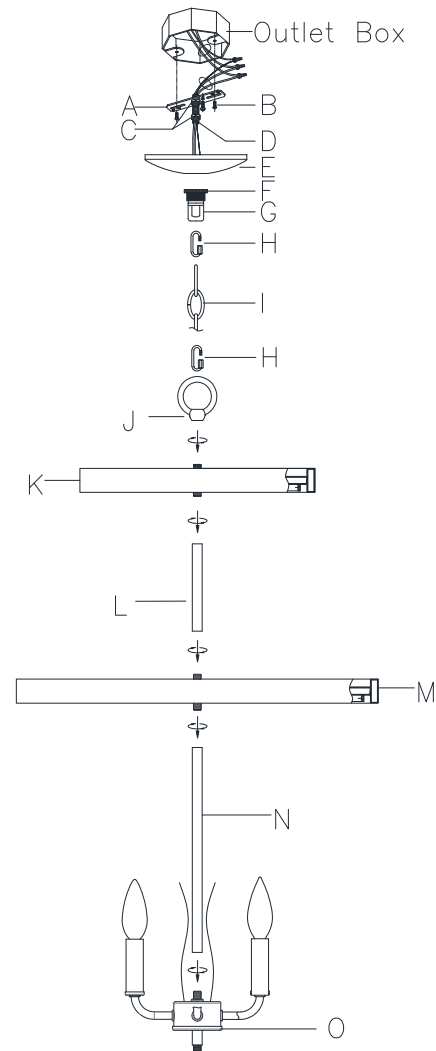

Candle Cover# CCV21070P-898



Notice: It is important to use proper chain pliers (not included) To OPEN and CLOSE the chain included with this fixture. Do not open them with other tools that may twist or stress the chain links. It is important to use proper chain pliers like the ones shown in the diagram.

COMPLETING THE INSTALLATION (Fig. 3)

16. Install (4) four candelabra base bulbs up to 60 watts each or CFL or LED equivalent (not included) in accordance with the fixture specification. — **DO NOT EXCEED THE MAXIMUM WATTAGE RATING! (NE PAS DEPASSER LA PUISSANCE NOMINALE MAXIMALE!**

17. Secure small metal ring (P) to bottom of all thread of socket assembly (O) and securing with nut (Q).

18. Hook strings of natural stones (C3 & D3) to top ring (K) and small metal ring (P) cyclically.

19. Hook string of natural stones (A3 & B3) to metal ring (M) and bottom ring (R) cyclically.

Your installation is now complete. Return power to outlet box and test the fixture.

IMPORTANT: Fixture should be installed by a qualified electrician to ensure proper wiring and installation.

Code	Rock Crystal String#	QTY/per item
A3	GL6893-S-C1	13
B3	GL6893-S-C2	13
C3	GL6893-S-T1	8
D3	GL6893-S-T2	8
E3	GL6893-S-B1	4
F3	GL6893-S-B2	4

Fig.2

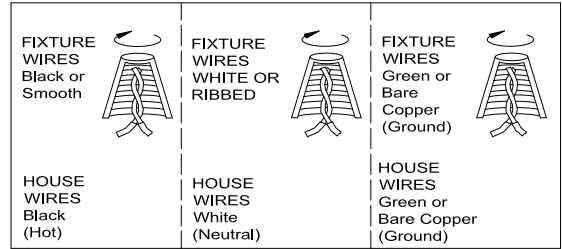
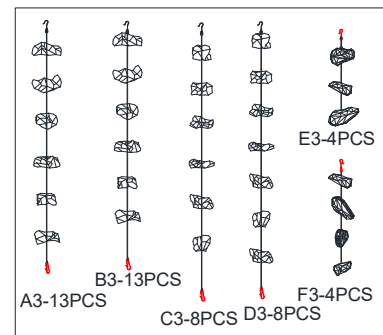
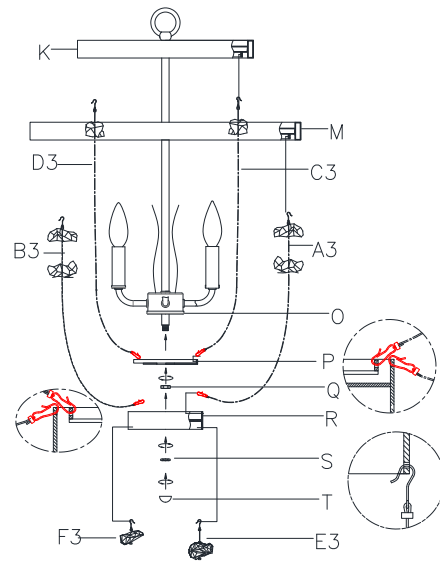

Fig.3



INSTALLATION INSTRUCTIONS

Item# N6893-898 (New. 2023/07/30)

READ AND SAVE THESE INSTRUCTIONS

WARNING! SHUT POWER OFF AT FUSE OR CIRCUIT BREAKER.

AVERTISSEMENT! COUPER LE COURANT AU NIVEAU DES FUSIBLES OU DU DISJONCTEUR.

MOUNTING THE FIXTURE (Fig.1) (Semi-flush)

1. Shut off power at the fuse box or circuit breaker box. If necessary, remove existing fixture and its mounting hardware.
2. Carefully unpack your new fixture and lay out all the parts on a clean area. Take care not to lose any small parts necessary for installation. Check that all parts are included as shown in the illustration.
3. Remove fixture loop (J) and ring (K1) from top ring (K).
4. Install metal ring (M) to large rod (N), then thread small rod (L) onto all thread of metal ring (M), attach top ring (K) by threading onto rod (L).
5. Attach canopy (F), flat washer (J), safety cable (E), lock washer (I) to all thread of top ring (K), securing with nut (G). Carefully feed wires through rod (N), metal ring (M), rod (L), top ring (K), canopy (F), flat washer (J), safety cable (E), lock washer (I) and nut (G).
6. Thread canopy screws (C) into pre-drilled holes in mounting plate (A). Spaced same distance apart as holes in canopy (F), and secure with nuts (D) provided.
7. Attached mounting plate (A) to outlet box (Not included) using mounting screws (B) (Size: #8-32N*L1"). The side of mounting plate (A) marked with "GND" must face out.
8. The support cable is provided to support the weight of fixture while wiring. Align fixture to mounting plate (A) and attach hook on end of support cable (E) into a slot located on mounting plate (A). Carefully allow support cable (E) to support weight of fixture while wiring.

CONNECTING THE WIRES (Fig. 2)

9. Connect the electrical wires as shown in Fig.2, making sure that all wire connectors are secured. If your outlet has a ground wire (green or bare copper), connect fixture's ground wire to it. Otherwise, connect fixture's ground wire directly to mounting plate (A) using green screw provided.

10. Tuck the wire connectors neatly into outlet box.

FINISHING THE INSTALLATION (Fig.1)

11. Raise canopy (F) over canopy screws (C) and secure with cap nuts (H).
12. Install (4) four candelabra base bulbs up to 60 watts each or CFL or LED equivalent (not included) in accordance with the fixture specification. — **DO NOT EXCEED THE MAXIMUM WATTAGE RATING! (NE PAS DEPASSER LA PUISSANCE NOMINALE MAXIMALE!**
13. Secure small metal ring (P) to bottom of all thread of socket assembly (O) and securing with nut (Q).
14. Hook strings of natural stones (C3 & D3) to top ring (K) and small metal ring (P) cyclically.
15. Hook string of natural stones (A3 & B3) to metal ring (M) and bottom ring (R) cyclically.
16. Attach bottom ring assembly (R) with nut (S) and finial (T) to all thread of socket assembly (O).
17. Hook string of natural stones (E3 & F3) to bottom ring (R) cyclically.

Fig. 1

Candle Cover# CCV21070P-898

Set#A-020-B

-Mounting Screw *2

-Green Screw

-Mounting Plate

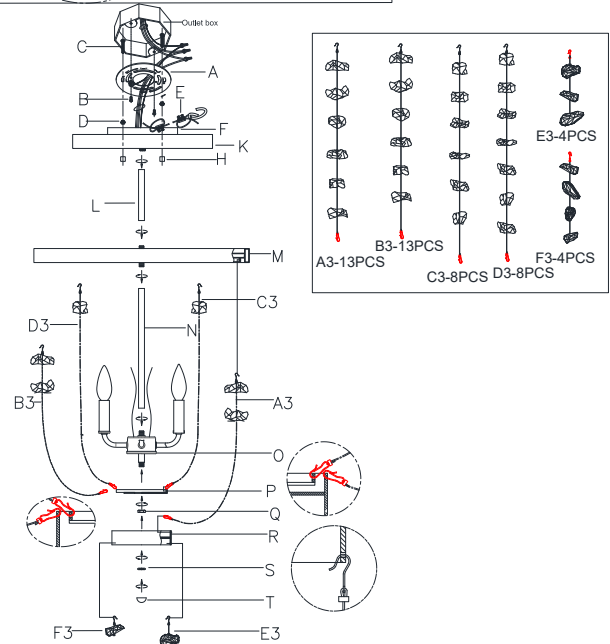
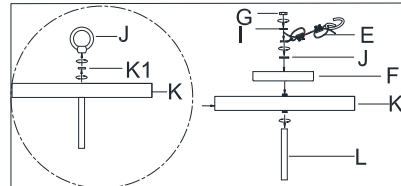
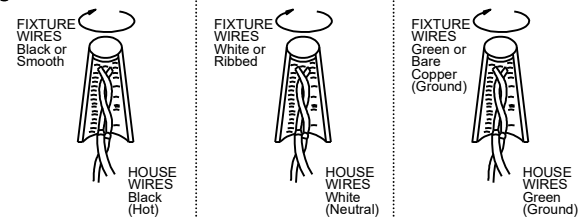

Fig. 2



Your installation is now complete. Return power to outlet box and test the fixture.

Note: Illustration (Fig.1) on this manual is for installation purposes only. It may or may not be identical to the fixture purchased.

Page 3/3

N6893-898

